

CRANES
and
TOOLS

VICARIO

Gru idraulica
di qualità
100% Italiana

OMV 40A

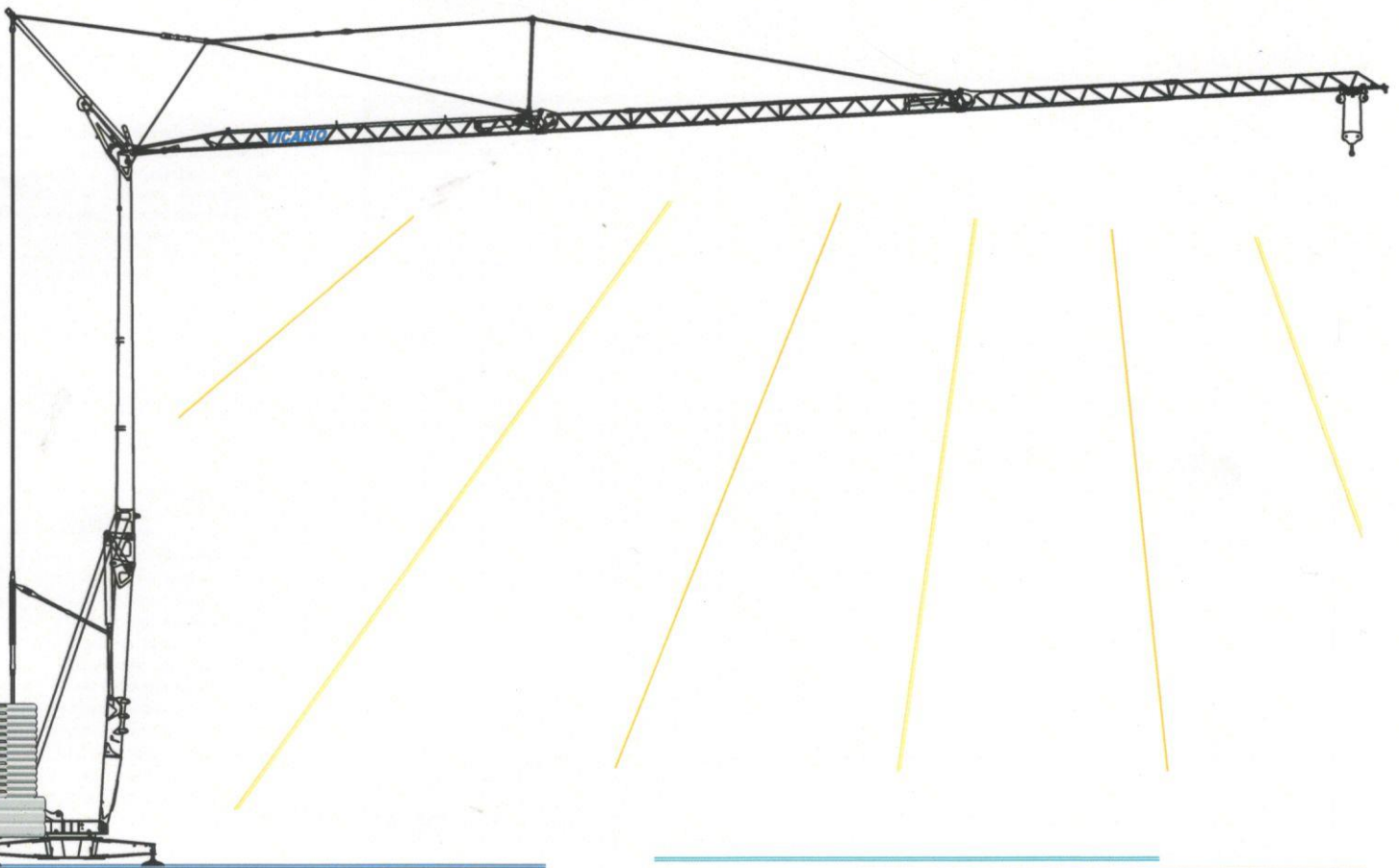

una novità delle Officine Meccaniche

Ein neuer VICARIO Kran

A new crane from VICARIO Industries

Une nouvelle grue de VICARIO

Una nueva grua de VICARIO

VICARIO

OMV 40A

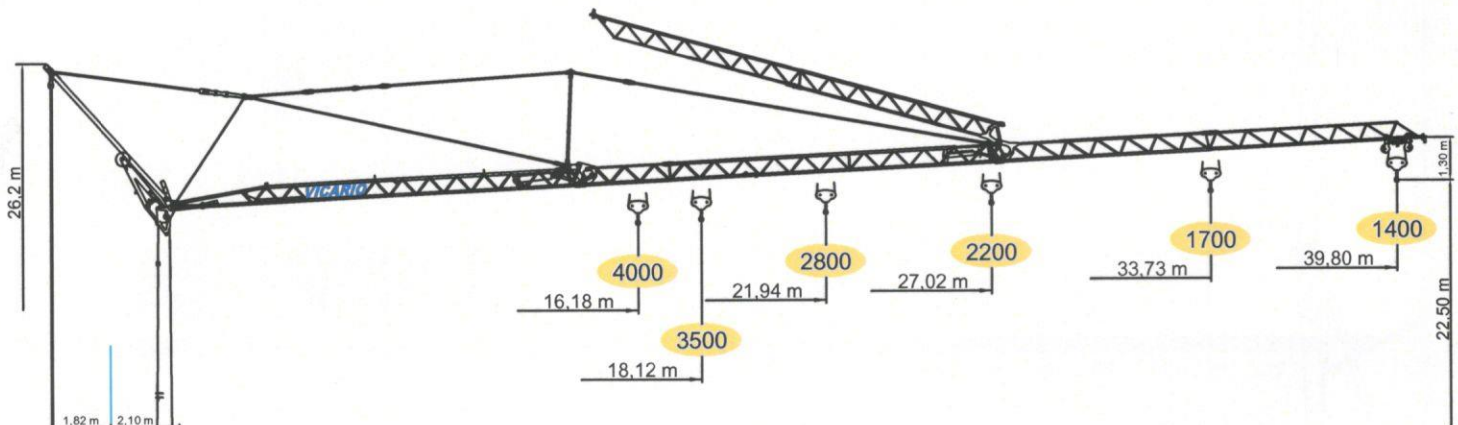
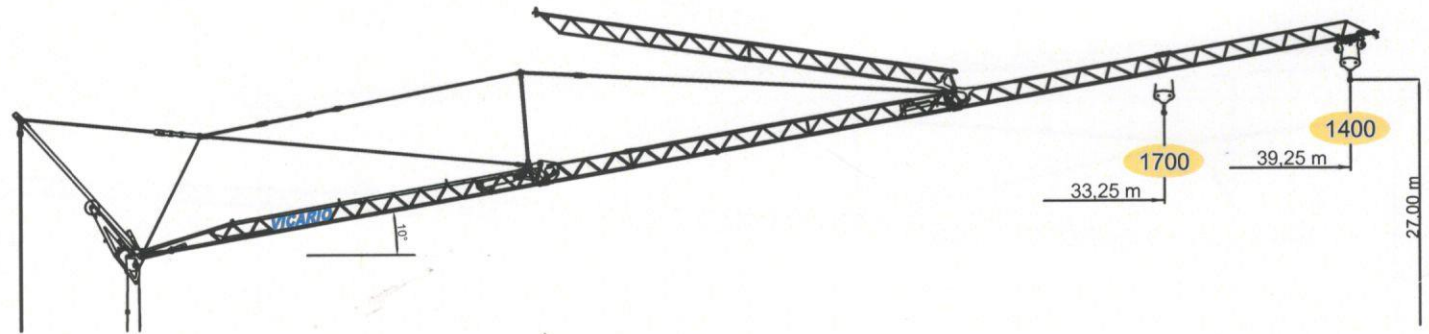
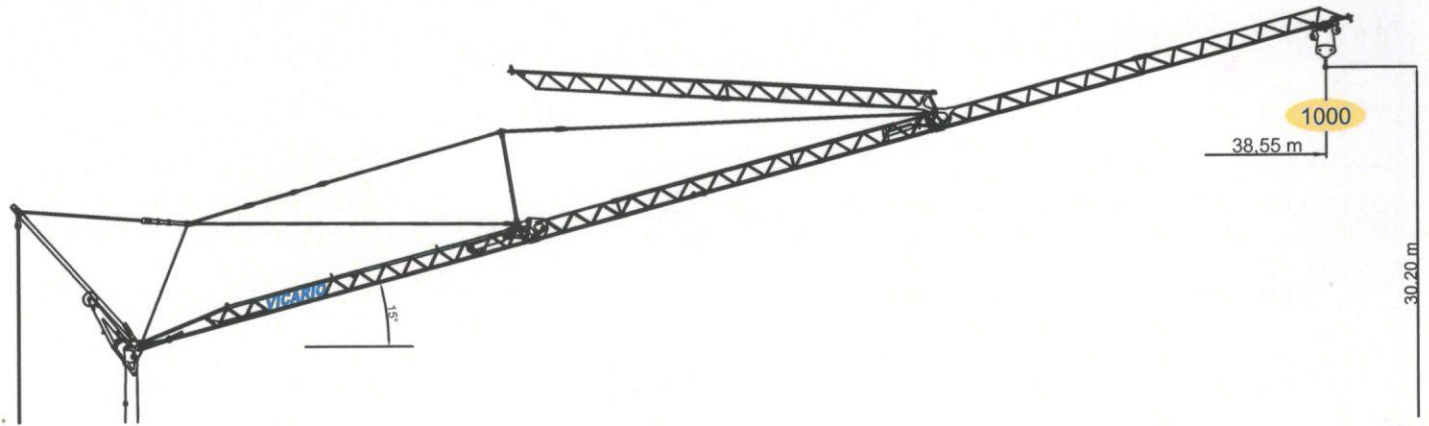

m	16.4	18	20	22	24	26	28	30	32	34	36	38	39.8
kg	4000	3530	3120	2790	2525	2230	2110	1950	1810	1685	1575	1480	1400



DOTAZIONE DI SERIE

Sollevamento "overdrive" a quattro velocità con inverter, rotazione e carrello a tre velocità con inverter, zincatura della struttura e dei tiranti, contrappeso, braccio impennabile, carrello rampante con motore e finecorsa alla base della torre, funzionamento con braccio ripiegato, comando a pulsantiera via cavo e radiocomando, carter di protezione per ralla e meccanismi, predisposizione per autozavorramento, armadio elettrico in acciaio inox, documentazione a norme CEE.

STANDARD FEATURES

4-speed lifting, 3-speed rotation and trolley with inverter control, galvanised structure, counterweight, pull-up jib, translation trolley with motor and limit switch at base of gantry, operation with folden jib, cable-operated pushbutton remote control and radio control, guard for slewing ring and mechanisms, designed to allow installation of self-ballasting device, stainless steel electrical cabinet, documentation in accordance with EU standards.

EQUIPEMENT DE SERIE







Levage à quatre vitesses, chariot et rotation à trois vitesses à contrôle électronique, galvanisation de la structure et des tirants, contrepoids, flèche relevable, moteur de chariot et fin de course à la base de la tour, fonctionnement bras replié, commande par câble et commande radio, carter de protection pour la couronne et les mécanismes, predisposition pour autolestage, armoire électrique en acier inox, documentation conforme aux normes CEE.

SERIENAUSSTATTUNG

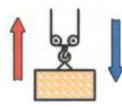
Heben mit vier Geschwindigkeiten, Laufkatze und Rotation mit drei Geschwindigkeiten, Strukturverzinkung, Gegengewicht, hochklappbarer Arm, aufsteigender Wagen mit Motor und Anschlag an der Basis des Turms, Funktionieren mit eingeklapptem Arm, Steuerung mit Druckknopfaste via Kabel und Funksteuerung, Schutzvorrichtungen für Drehverbindungen und Mechanismen, Vorbereitung für Selbstballasteinnahme, elektrischer Schrank aus rostfreiem Stahl, Dokumentation gemäß EC Vorschriften.

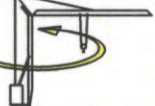
DOTACION DE SERIE

Levantamiento a cuatro velocidades, carro y rotación a tres velocidades con control electrónico, galvanización de la estructura, contrapeso, brazo empinable, carro rampante con motor y fin de carrera en la base de la torre, funcionamiento con brazo replgado, faccionamiento por pulsadores via cable y radioccontrol, cárter de protección para corona de giro y mecanismos, predisposición para autocontrapeso, armario eléctrico de acero inox, documentación a normas CEE.

	400V (±10%) 50 Hz		18kVA		
	m/l'	▶	▶▶	▶▶▶	▶▶▶▶
	kg	6,3	21	31	48
	kW	4000	4000	1400	1400
15 (Inverter)					
	m/l'	▶	▶▶	▶▶▶	
	kg	17,8	28,6	53,5 (↗39,3)	
	kW	3 (Inverter)			
	n/l'	▶	▶▶	▶▶▶	
	kg	0,13	0,29	0,58	
	kW	3,7 (Inverter)			
	min	▶			
	kW	10			
	19.830 kg			8.100 kg + 19.500 kg	
	8100 kg	5400 kg	2700 kg	0 kg	
P1	13233 kg 14077 kg *	11095 kg 11907 kg *	8958 kg 9737 kg *	6820 kg 7567 kg *	
P2	14697 kg 13853 kg *	14135 kg 13323 kg *	13572 kg 12793 kg *	13010 kg 12263 kg *	

OMV 40A

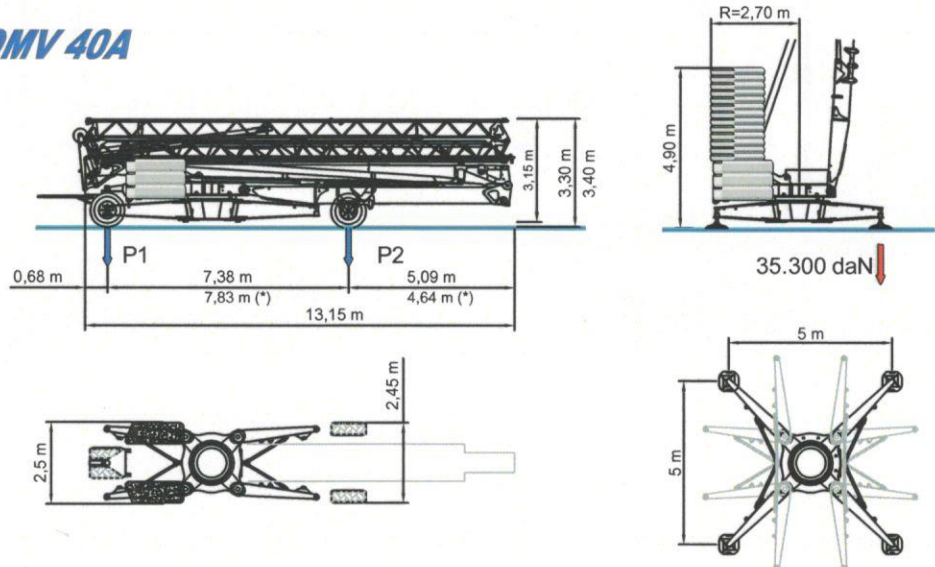

OMV 40B

Variante a richiesta del cliente. Variation on request. Variation sur demande. Variation auf Anfrage. Variación bajo petición.

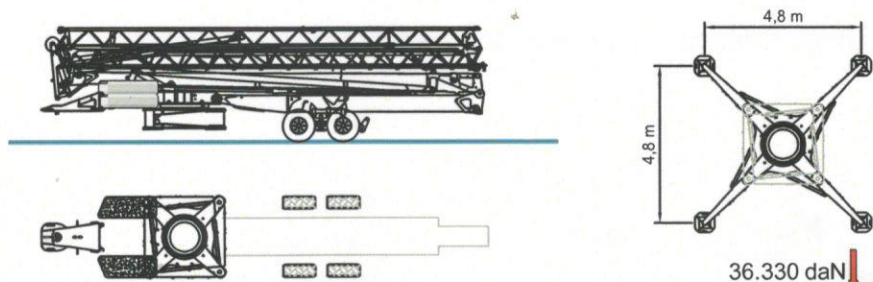

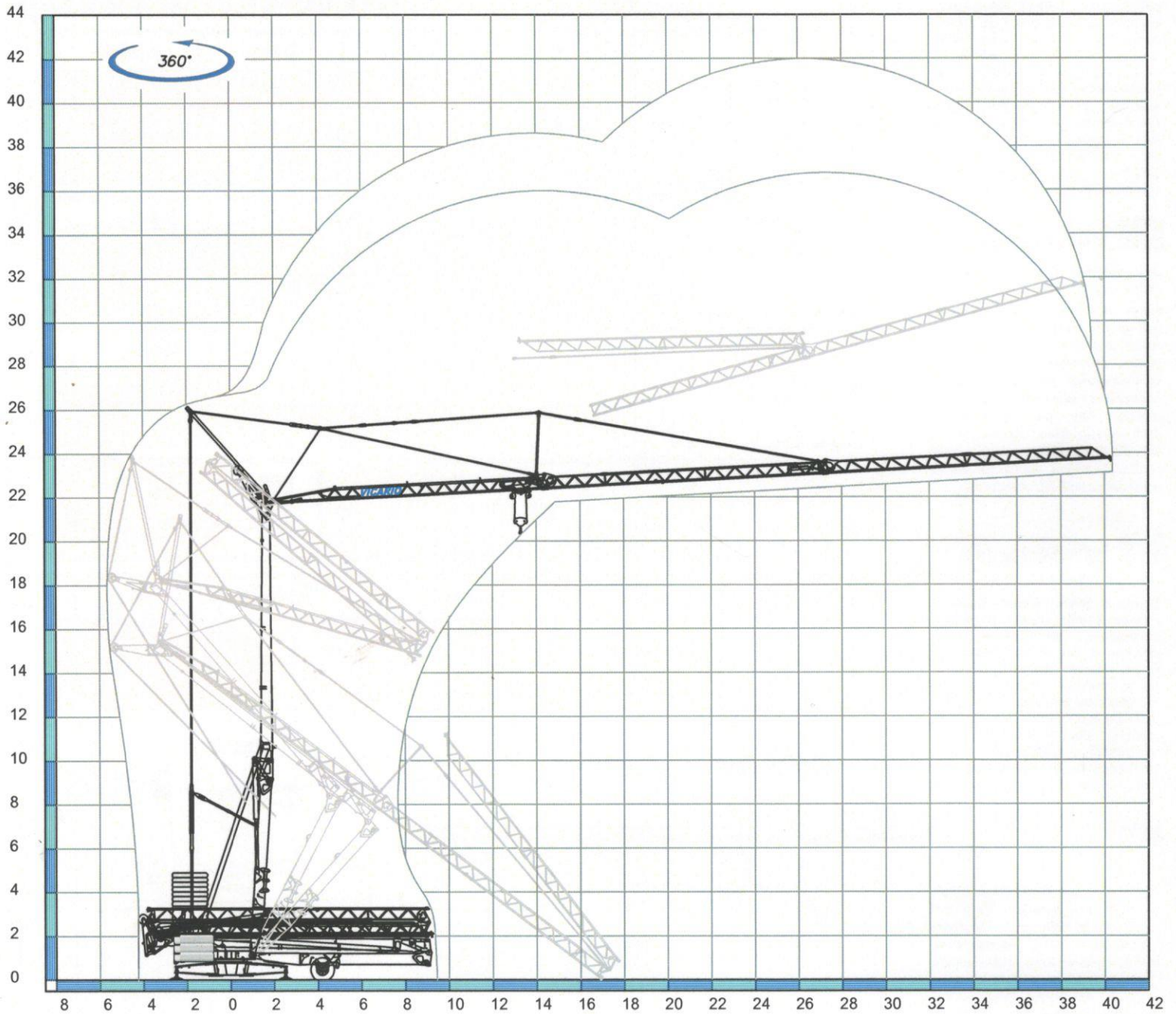

Sequenza di montaggio su 360°. Aufstellvorgang über 360°. Déroulement de montage sur 360°. Erection procedure on 360°. Montaje sobre 360°.

CRANES
and
TOOLS **VICARIO**
Officine Meccaniche Vicario S.p.a.

Via Piola, 4

28013 Gattico (NO) ITALIA

Tel. 0322 846690 Fax 0322 846692

Internet: www.vicariogru.com E-Mail: omv@vicariogru.com

Agente di zona: